

D-MAX
S-CAB

DO WHAT OTHERS CAN'T

ISUZU
NEVER STOP

BUSINESS CLASS BUSINESS PICKUP.



CLEANER AND GREENER

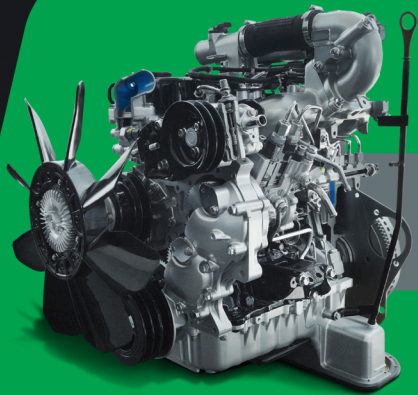

Over **10** Lakh*
engines sold worldwide

**Powerful & proven engine with
VGS technology**
For unbeatable performance.

BS6
STAGE 2

*Cumulative data for all the generations put together.



Low 6.3m turning radius
To access even the narrowest of roads.



Refined 5-speed gearbox with overdrive
For precise and smooth drivability.



Aerodynamic design
For stability and lower NVH.

THE ONE YOU CAN DEPEND ON.

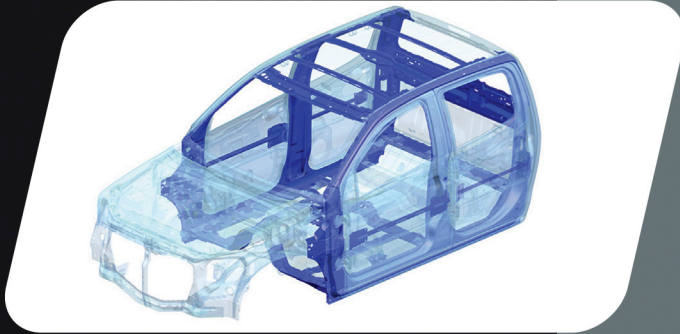

High tensile steel body

Provides superior strength and ruggedness for the long run.

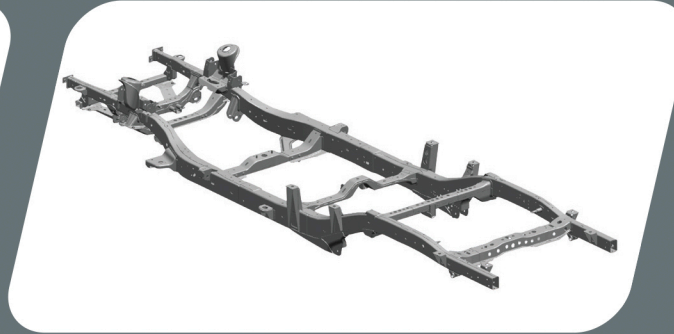

iGRIP Platform

Modern, new generation platform for high performance.

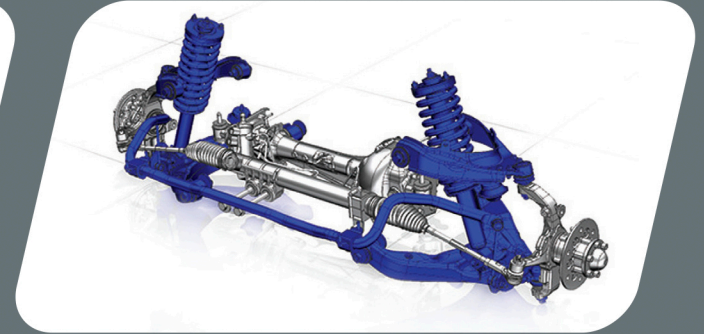

Stronger suspension

Heavy duty suspension that provides optimum load carrying capability.

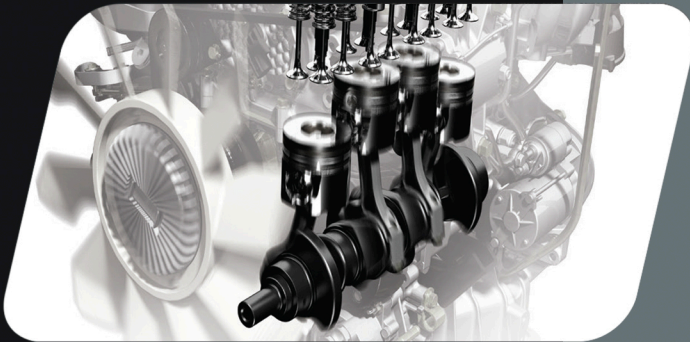

Graphite coated pistons

Extends engine life by preventing wear and tear during cold starts.



Protective all-round electro deposition coating

Prevents rusting and provides long-lasting performance.



Tested for over 40 LAKH km*

Making the D-Max S-Cab an extremely reliable product.

#40 LAKH km is the sum of distance covered under various test conditions in multiple vehicles.

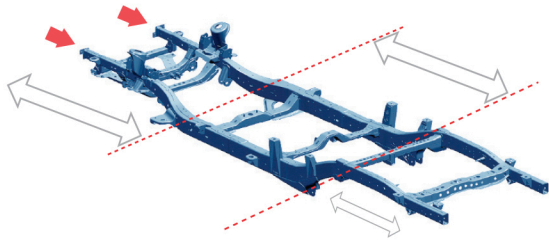

Collapsible chassis with crumple zones

Provides more safety to occupants during front and rear collisions.

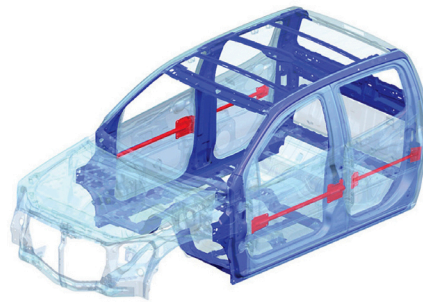

Cross-car front beam and side-door intrusion beams

Provides added safety from front and side impacts.

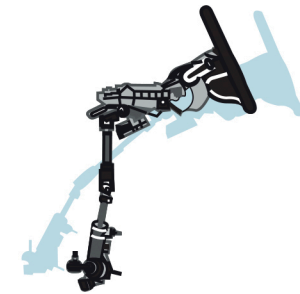

Collapsible steering column

Added safety for the driver in the event of a frontal collision.



Efficient braking system

With 26.6 cm brake boosters, ventilated disc and twin pot calipers.

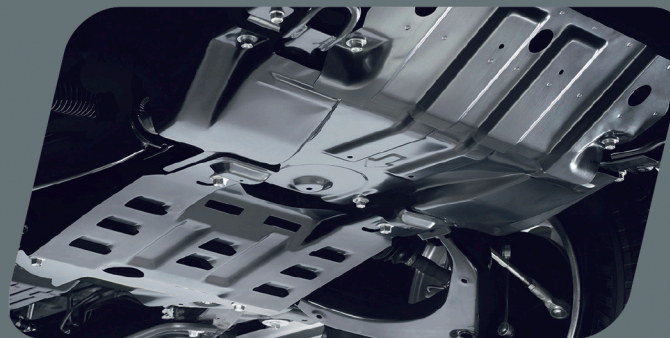

Underbody protection kit

Steel skid plate and engine bottom guard to safeguard the key vehicle aggregates.



LSPV (Load Sensing Proportioning Valve)

An intelligent braking system that corresponds to the load and reacts accordingly preventing wheel skidding.

MAKES A TOUGH JOB EASIER.



Improved Rear Seat Angle for Comfort

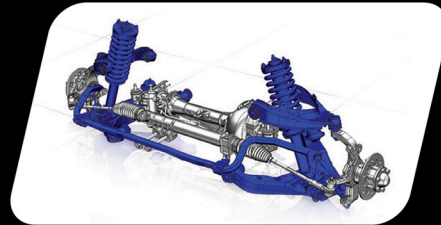

Front independent double wishbone suspension

Heavy duty suspension for superior comfort and unmatched on-road durability.

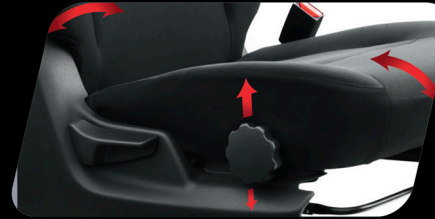

6-way adjustable driver seat

Customizable support for the driver's comfort.



AC with blower, heater, dust and pollen filter

Maximum comfort for all passengers.



Large wheels (40.64 cms.) with tubeless tyres

For better comfort and safety.



Powered windows with driver auto-down

Automated convenience for the driver and the passengers.

CAR LIKE CABIN WITH LARGE ORVM



Multiple storage spaces
More space while on the go.



Rear 60:40 tip-up seats
Flexibility to create extra cargo space.



Large cargo bed
A 2.2 m² load deck that can efficiently carry all your load.



Dual position tailgate handle
Facilitates easy opening during loading and unloading.

Disclaimer: Accessories shown are not part of the standard equipment

TECHNOLOGY THAT MOVES YOU. CONVENIENCE THAT FREES YOU



Multi-Information Display (MID)

Advanced MID gives driver information about vehicle performance parameters. Odo meter, Speedometer, digital speed read out, instant mileage and average mileage, ambient temperature, elapsed time, current fuel range, DPD level indicator, AdBlue level indicator. Car like electroluminescent Instrument cluster



Co-driver sliding seat

Better comfort and ease for the co-passenger in the front seat.



Rear parking sensor

For maximum ease of parking.



High mount stop lamp

Extra precaution for the vehicle approaching from the rear.



Variable speed

Intermittent Wipers

Interval between wiper sweeps can be adjusted within a range of approximately 1.5 to 15 seconds. Better visibility during driving in rainy conditions. Enhanced safety



Central Locking System

More control for the driver.

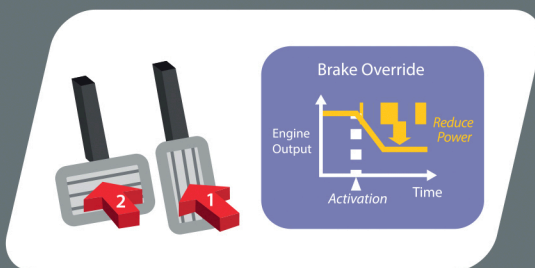

Brake Override System

An intelligent system that reacts to panic braking of the vehicle, even when the accelerator is pressed with the brakes.

FOR EVERY ROAD, EVERY LOAD.



*Images are for representative purpose only. T&C apply**

PEACE OF MIND FOR EVERY KILOMETRE



ISUZU HEALTH REPORT



Customer name XXXXXXXXXXXXXXXXXXXXXXXXXXXX
 VIN XXXXXXXXXXXXXXXX
 Travel distance XXXXXkm

TIMING OF NEXT RECOMMENDED INSPECTION



Recommended inspection date

DD/MM/YYYY

Travel distance (estimate)

XXXX km

*Images and table are for representative purposes only. T&C apply**

SEVERE CONDITION SUMMARY



Vehicle usage type



Towing



Start/stop frequency



Mountain travel



Operation in cold areas



DPD (DPF) regeneration status



INSPECTION ITEMS ON THIS VEHICLE



Engine system: engine oil, engine oil filter, fuel filter, air cleaner element, exhaust brake



Transmission/Transfer gear oil, Clutch fluid, Automatic transmission fluid



Exhaust pipe and mounting looseness



Steering linkage damage to loose or excessive play, King pin



Exhaust throttle



N/A



N/A



N/A



N/A

SUMMARY OF VEHICLE USAGE



Fuel economy



Brake pedal usage



Exhaust brake usage



Accelerator pedal usage (acceleration)



Accelerator pedal usage (accelerator level)



* The necessary maintenance items vary depending on the vehicle. For details, be sure to refer to the Owner's Manual.



EVERYONE NEEDS A WORKHORSE



TRUSTED JAPANESE QUALITY



Multiple storage spaces



2 stage opening rear door with easy one touch operation

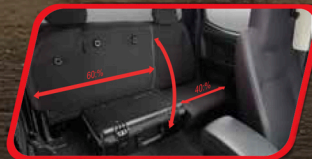

Rear 60:40 tip-up seats



Multi-Information Display (MID)



LSPV (Load Sensing Proportioning Valve)

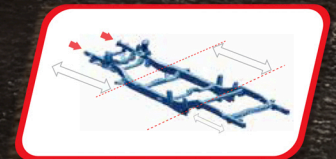

Collapsible chassis with crumple zones

*Images are for representative purpose only. T&C apply**

SPECIFICATIONS AND FEATURES

**D-MAX
S-CAB**

MODEL	S-CAB 2WD HR	S-CAB EX	S-CAB EX CBC
ENGINE			
Type	4 Cylinder, Common Rail, VGT Intercooled Diesel		
Cubic Capacity	2499 cc		
Engine Max Power	58 kW/78 hp @ 398 rad/s (3800 rpm)		
Engine Max Torque	176 Nm @ 157 - 251 rad/s (1500 - 2400 rpm)		
Emission level	BS6 Stage II		
TRANSMISSION			
No. of speeds	5 Speed		
Shift Type	Manual		
SUSPENSION			
Front	Double Wishbone, with Coil Springs & stabilizer		
Rear	Semi-Elliptic Leaf Spring		
WHEEL			
Wheel Rim Size	16 x 6.5J-33		
Tyre Size	205R16C		
Tyre Type	Radial Tubeless		
BRAKES AND STEERING			
Brake Type	Hydraulic Brake with large booster (26.67 cm) and LSPV		
Front Brake	Ventilated Disc with Twin Pot Caliper		
Rear Brake	Drum		
Steering Type	Hydraulic Power Assist with Tilt Adjustment		
DIMENSIONS			
Overall Vehicle (LxWxH)	5200 mmx1860 mmx1780 mm	5045 mmx1860 mmx1780 mm	
Wheelbase	3095 mm		
Cargo Deck Inner (LxWxH)	1485 mmx1530 mmx465 mm		
Turning Circle Radius	6.3 m		
CAPACITY			
Fuel Tank	55 litre		
DEF Tank	14.7 litre		
Seating capacity	D+4		
WEIGHT			
Payload	995 kg	1025 kg	1140* kg
GVW		2850 kg	
Kerb Weight	1855 kg	1825 kg	1710 kg

FEATURES	S-CAB 2WD HR	S-CAB EX	S-CAB EX CBC
COMFORT/ CONVENIENCE			
Improved Rear Seat Recline Angle for enhanced comfort	Y	Y	Y
Power Steering with Tilt Adjustment	Y	Y	Y
Air Conditioner with Heater	Y	-	-
Dust & Pollen Filter	Y	-	-
Seat-belt Height Adjuster Front seats	Y	Y	Y
Inner & Outer Dash Noise Insulation	Y	-	-
Moulded Roof Lining	Y	Y	Y
Clutch Footrest	Y	-	-
Advanced Electroluminescent Multi Information Display console	Y	Y	Y
ORVMs with Adjustment Retention	Y	Y	Y
Roof Assist grip for Co-driver	Y	-	-
Fabric Seats	Y	Y	Y
Co-driver seat sliding	Y	Y	Y
Carpet Floor Cover	Y	Y	Y
Sun Visor for Driver and Co-driver	Y	-	-
Gear Shift Indicator	Y	Y	Y
UTILITY			
12V Mobile Charging Point	Y	Y	Y
Retractable Cup and Coin holders on Dashboard	Y	Y	Y
Door Trims with Bottle Holder and Pocket	Y	Y	Y
Twin Glove Box	Y	Y	Y
Centre armrest with storage space	Y	-	-
Centre Storage Tray	-	Y	Y
4 Speakers with pre-wiring	Y	-	-
Antenna	Y	-	-
Rear 60 : 40 Tip Up Seats	Y	Y	Y
SAFETY/ SECURITY			
Hydraulic Brake with large booster (26.67 cm) and LSPV	Y	Y	Y
Ventilated Front Disc Brake with Twin Pot Caliper	Y	Y	Y
Brake Override System	Y	Y	Y
Chassis & Cabin with Crumple Zones	Y	Y	Y
Cross Car Front Beam	Y	Y	Y
Door Side Intrusion Beams	Y	Y	Y
Steel Skid Plate	Y	Y	Y
Collapsible Steering Column	Y	Y	Y
Variable Intermittent Windshield Wiper	Y	Y	Y
Day & Night IRVM	Y	-	-
Rear Parking Assist System	Y	Y	Y
Warning Lights & Buzzers	Y	Y	Y
All seats seat belts	Y	Y	Y
Child lock on rear doors	Y	Y	Y
Tubeless Tyres	Y	Y	Y
Front and Rear seats with head rests	Y	Y	Y

* To be determined after body fabrication

PICK FROM THE BEST.



For more information, visit us at: www.isuzu.in



-  ISUZU Motors India
-  isuzumotorsindia
-  IsuzuMotorsIndia
-  @IsuzuIndia
-  +91 89255 27644

Disclaimer -The ISUZU D-MAX S-CAB vehicle can only be registered as 'Commercial Vehicle' in India and can only be driven by person/s holding a valid 'Light Commercial Vehicle' license or such other as may be prescribed under the relevant norms prevalent under different states in India in line with the Motor Act 1988 and Central Motor Vehicle Rules, 1989 as amended from time to time. The information provided in this brochure should be viewed as accurate at the time of going to print. Images shown are only for representation purpose . The illustrations/images may show optional equipment and accessories which are not part of the standard package. The product specifications/variants/colours shown in the brochure are subject to change without notice and the manufacture reserves the right to change/modify elements of vehicle specifications and equipment/accessories. Actual vehicle colours in the brochure may vary from those shown owing to limitations in printing. Model series ISUZU D-MAX S-CAB comply to Bharat Stage 6 Stage 2 norms. Date of going to print - 01st June, 2025

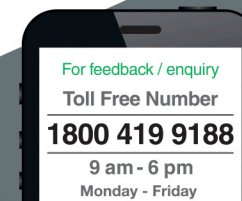

#40 LAKH km is sum of distance covered under various test conditions in multiple vehicles.